

# Data Sheet

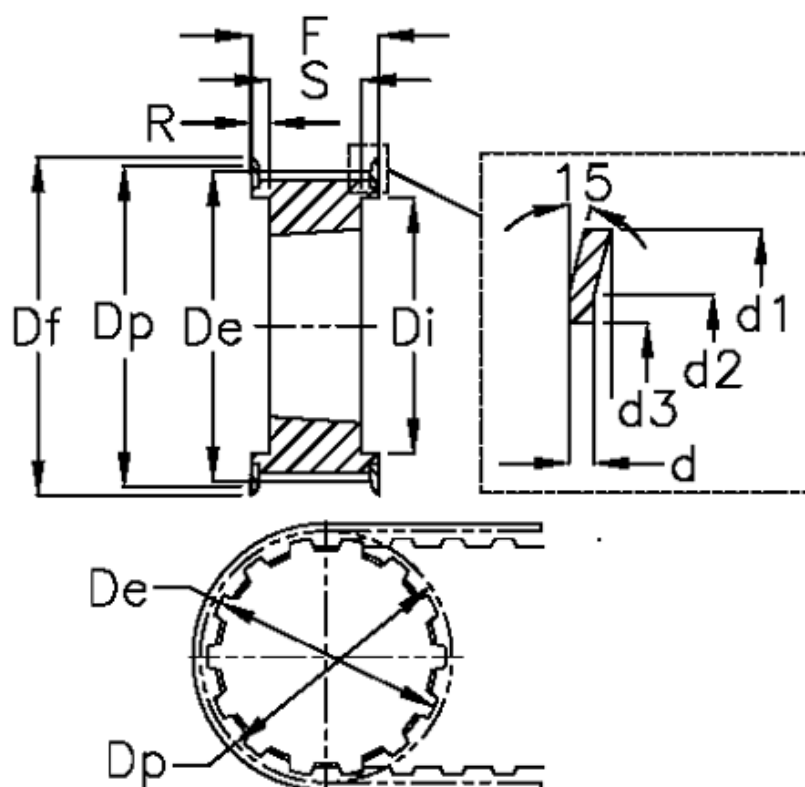

Article number: 604133029115  
 Description: Taper bored timing belt pulley  
 HTD 29 14M 115 TL 2517

## Measures



d = 2.5	F = 133	Weight = 4
d1 = 138	Flange type = F43	Width = 115
d2 = 132	For bushing = 2517	
d3 = 121	Max bore = 60	
De = 126.57	r = 44	
Df = 138	S = 45	
Di = 100	Tooth number = 29	
Dp = 129.23	Type = 14M	